

SATA
SERIES

5650

1.27mm Pitch Plug 7極 RA
1.27mm Pitch Plug 7Pos. Right Angle

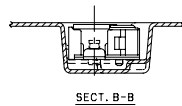
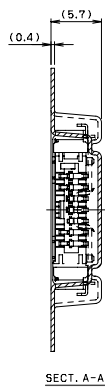
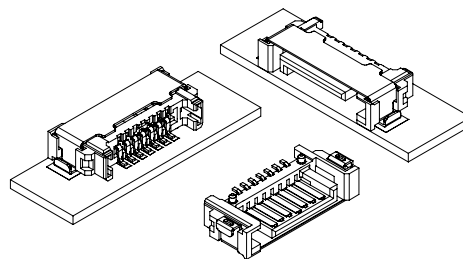
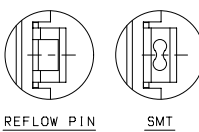
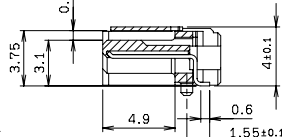
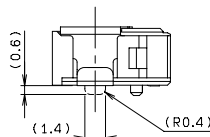
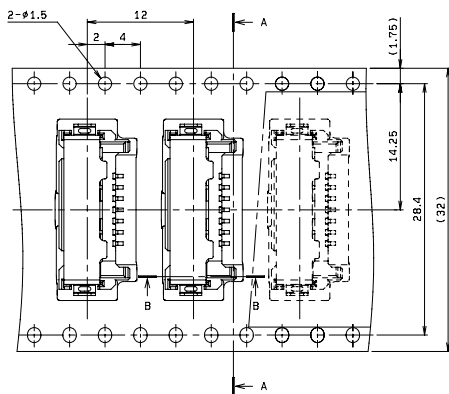
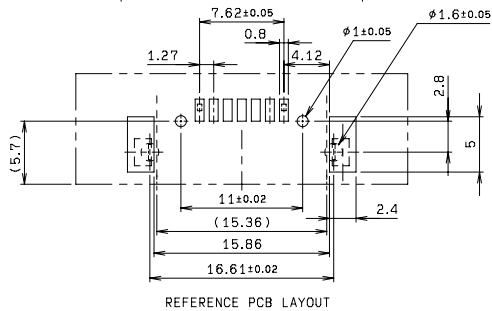
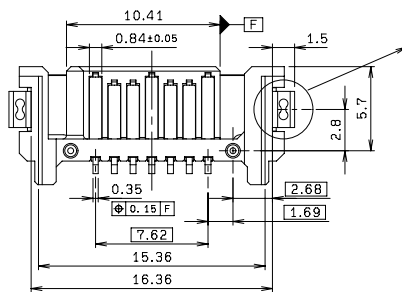
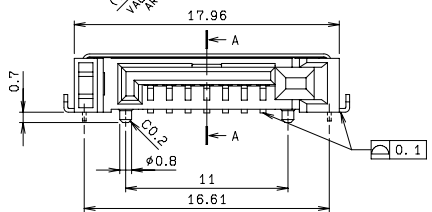
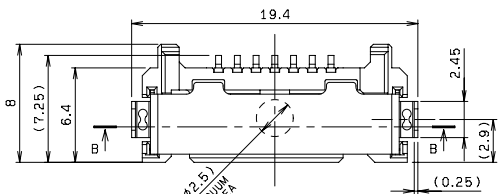

注文コード/ Ordering Code

RoHS 対応品
RoHS Compliant Product

Part No. 14 5650 007 00X 896+

- 0: ボス付・シェル付/SMT
With Bosses & Shell type
- 1: リフローピンタイプ・ボス付
Reflow Pin type, With Bosses
- 2: ボス無し・シェル付/SMT
Without Boss, With Shell type

梱包数量: 1,000個/リール
PACKING QUANTITY: 1,000/Reel